

WATERMAN  
**TYPE "A"**  
AND  
**TYPE "B"**

CONSTANT DOWNSTREAM  
LEVEL CONTROL GATES

- AUTOMATIC
- NO OPERATOR, NO MOTOR
- SIMPLE, ACCURATE, FAST AND RELIABLE
- FOR FLOOD CONTROL
- FOR WATER MANAGEMENT SYSTEMS
- FOR IRRIGATION
- CONSTANT DOWNSTREAM  
LEVEL CONTROL

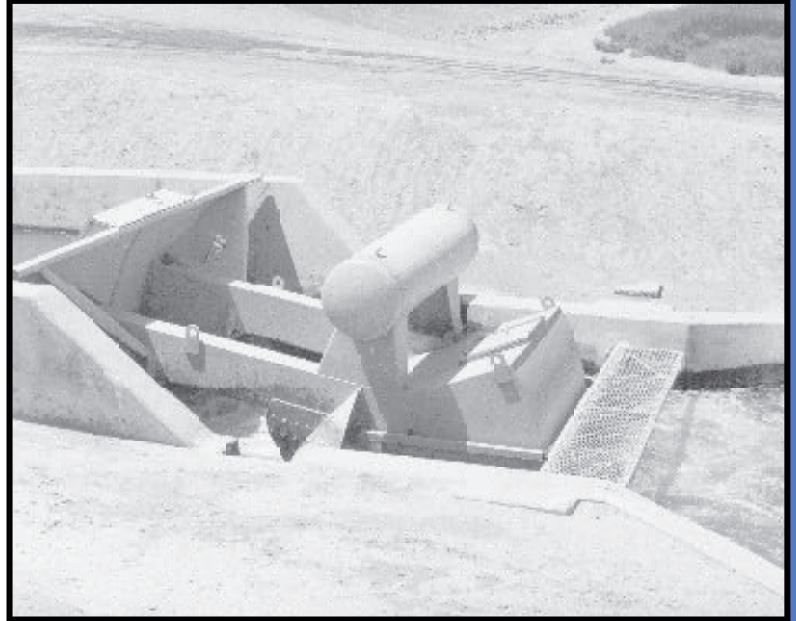

**TYPE "A" FOR OPEN CHANNEL FLOWS**



**TYPE "B" FOR ORIFICE APPLICATIONS**

**WATERMAN**

# TYPE "A" AND TYPE "B"

## CONSTANT DOWNSTREAM LEVEL CONTROL GATES

Automatic gates provide constant downstream water level control regardless of upstream level conditions or downstream demands.

This remarkably constant control is achieved without any operators, without motors or power supply, and irrespective of upstream level conditions.

These Waterman Type "A" and Type "B" gates are designed to respond automatically and instantly to downstream level changes to maintain a constant downstream water level. They are ideally suited for:

- "Demand control" on open canals
- Canal and network automation
- Control of detention basins and reservoirs
- Flood Control
- Channel water level maintenance
- "Constant source" flow for cooling and recirculation systems and water and wastewater treatment facilities.
- Constant downstream discharge when used with a Waterman baffle distributor
- Control of head (headbreaking)

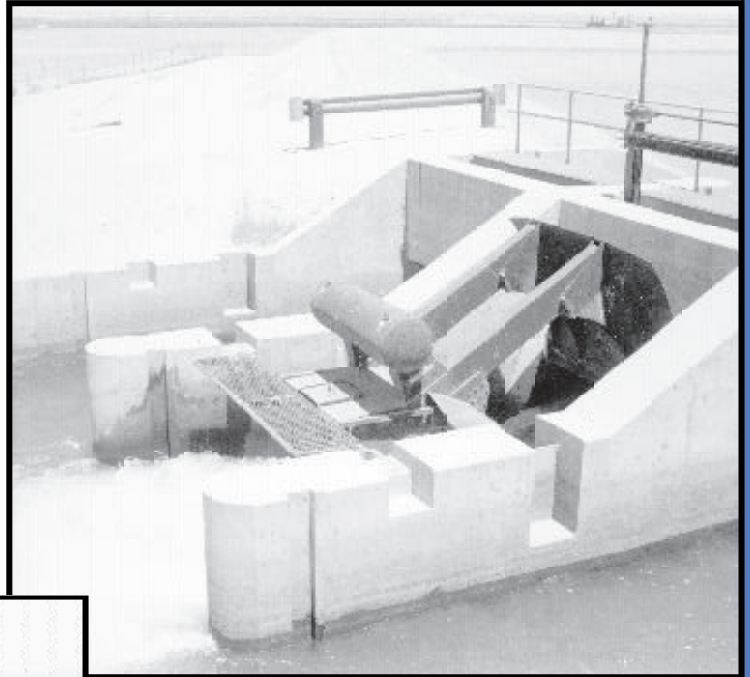

Type "B" gate located on the outlet of a large storm water detention basin.

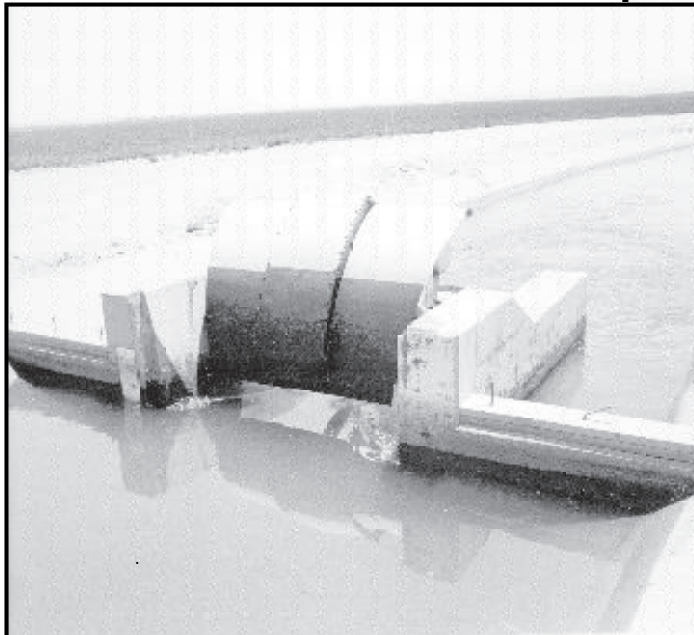

Type "A" gate located as a regulator on a small irrigation canal.

## PRINCIPLE OF OPERATION

With the downstream water level at the pivot axis, the gate is balanced so that the moment caused by the center of gravity about the hinge is equal to the moment caused by the upthrust of the float. Any change in the water level alters this stability, causing the gate to rotate, thereby increasing or decreasing the discharge to restore the water level to the pivot centerline. If the water level falls, the reduced flotation couple allows the gate to open increasing the discharge into the downstream channel. Conversely, if the water level rises, the increased flotation couple shuts the gate, decreasing the discharge and maintaining the water level at the pivot centerline.

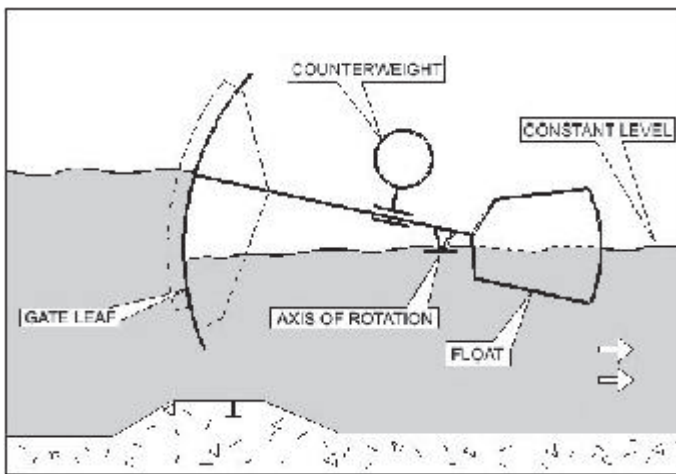

### TYPE "A"

Maximum upstream head 6.5 Ft. for largest gates

No breastwall

Designed for continuous canal lengths with upstream level variations relatively small.

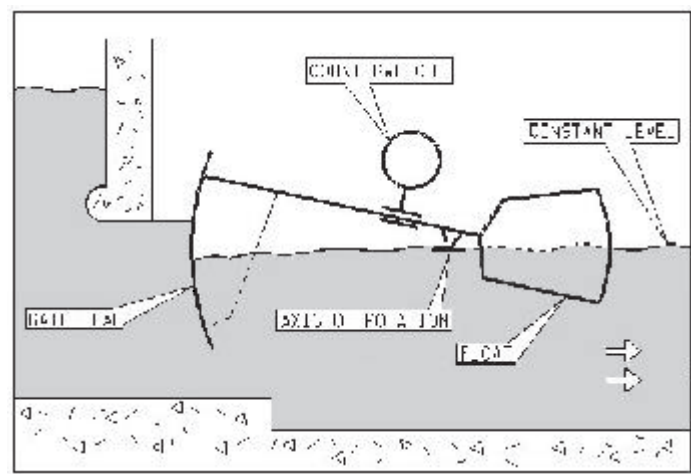

### TYPE "B"

Maximum upstream head 36 Ft. for largest gates

Breastwall or other orifice needed

Designed for higher heads and greater upstream level requirements working against breastwall or other opening.

## GATE CONSTRUCTION

The Waterman Type "A" and Type "B" constant downstream level gates basically consist of a radial leaf of trapezoidal shape, a float that is rigidly fixed to the moving frame downstream of the pivot axis, a float shield tank in which the inlet butterfly valve is fixed, a counterweight tank and a frame structure which consists of the main shaft with bearings and beams connecting the float to the gate leaf.

The walkway is a standard feature for all larger sizes of Waterman Type "A" and Type "B" gates. Waterman Type "A" gate has a damper on the upstream surface of the leaf and bottom/sides metal seats. Waterman Type "B" gate has an embedded metal intake structure.

# THE WATERMAN TYPE "A"

Waterman Type "A" gates are designed to maintain a constant downstream water level irrespective of the upstream variations, provided that the upstream level variations are small enough to be satisfied by a surface gate.

Two Type "A" configurations are available. The low head has a wider gate leaf of lesser height, while the high head gate leaf is not as wide, but has greater height. At equal loss of head, a Waterman Type "A" low head gate allows a bigger flow, but the maximum permissible head is less.

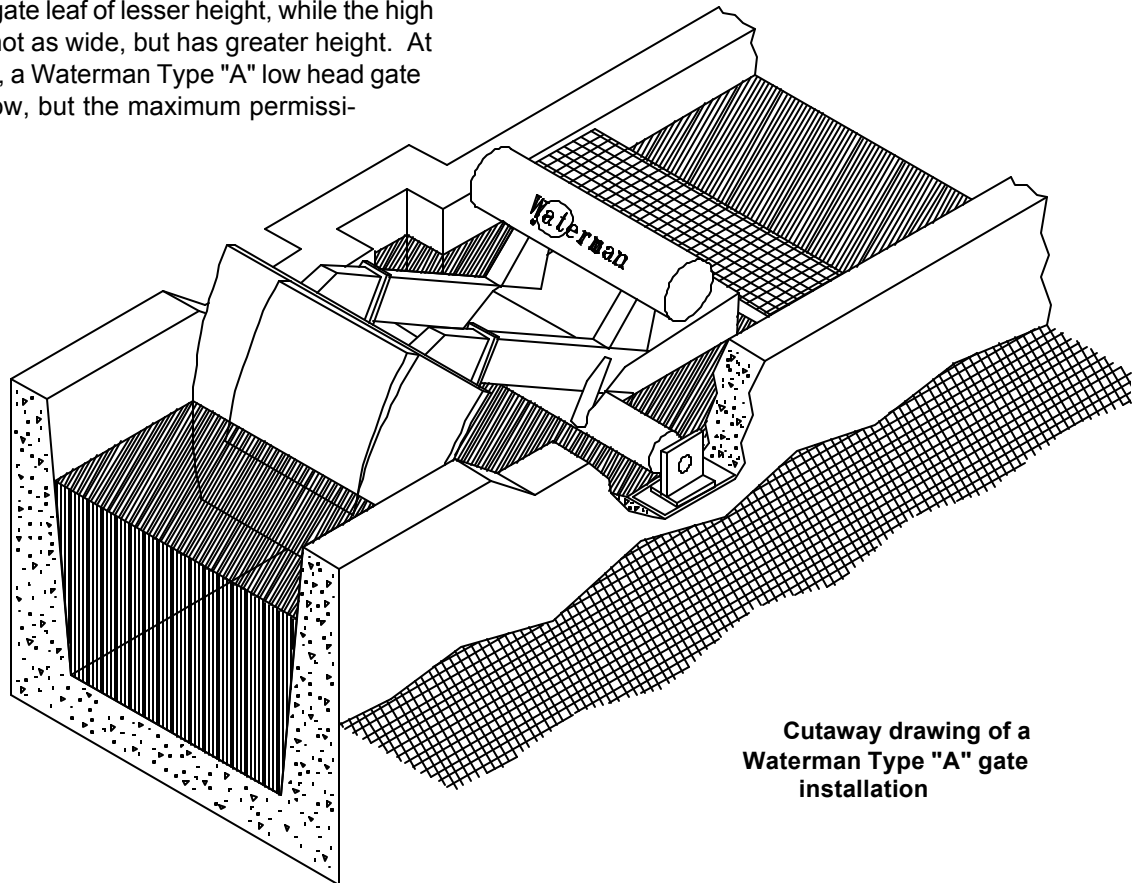

Cutaway drawing of a  
Waterman Type "A" gate  
installation

## GATE SELECTION

Selection is based on the required hydraulic performance of the installation.

The gate to be selected is the smallest one (smallest index number) whose head-discharge curve, represented on the selection charts, encompasses all possible head/discharge operating points which may be encountered for the installation.

For example, the following differential [1] under which the maximum discharge [2] must still be delivered.

[1] and [2] define point A

Maximum head differential [3] and largest discharge [4] to be delivered under this maximum head differential.

[3] and [4] define point B

See following page.

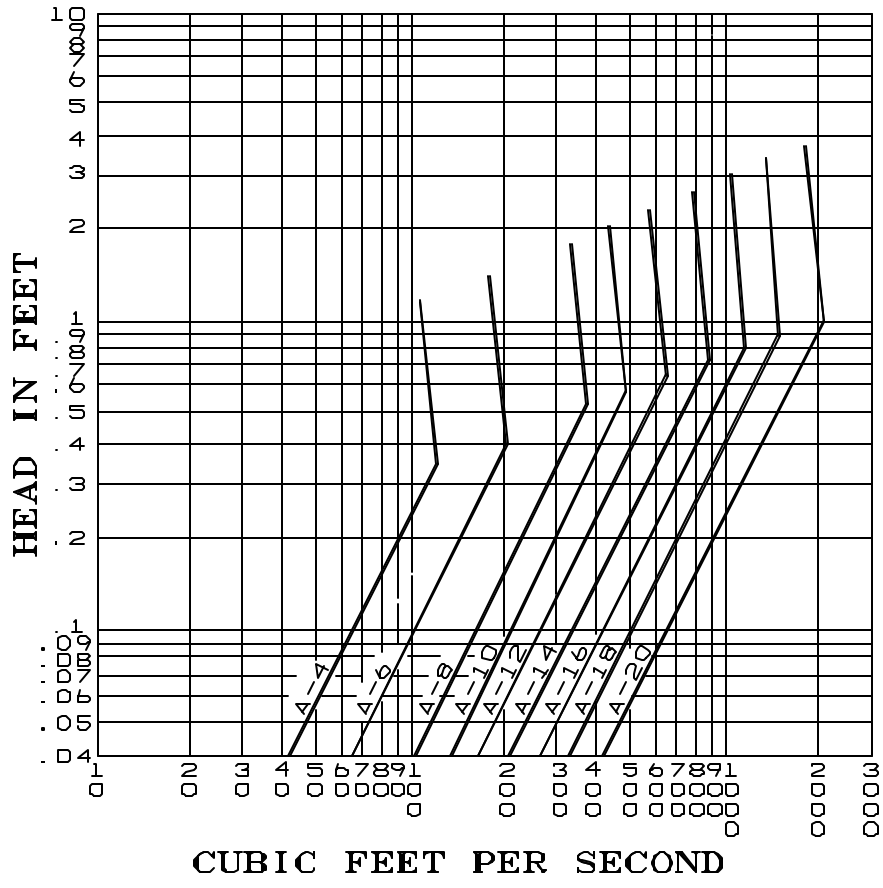

**TYPE "A"  
HIGH HEAD  
GATE SELECTION CHART**

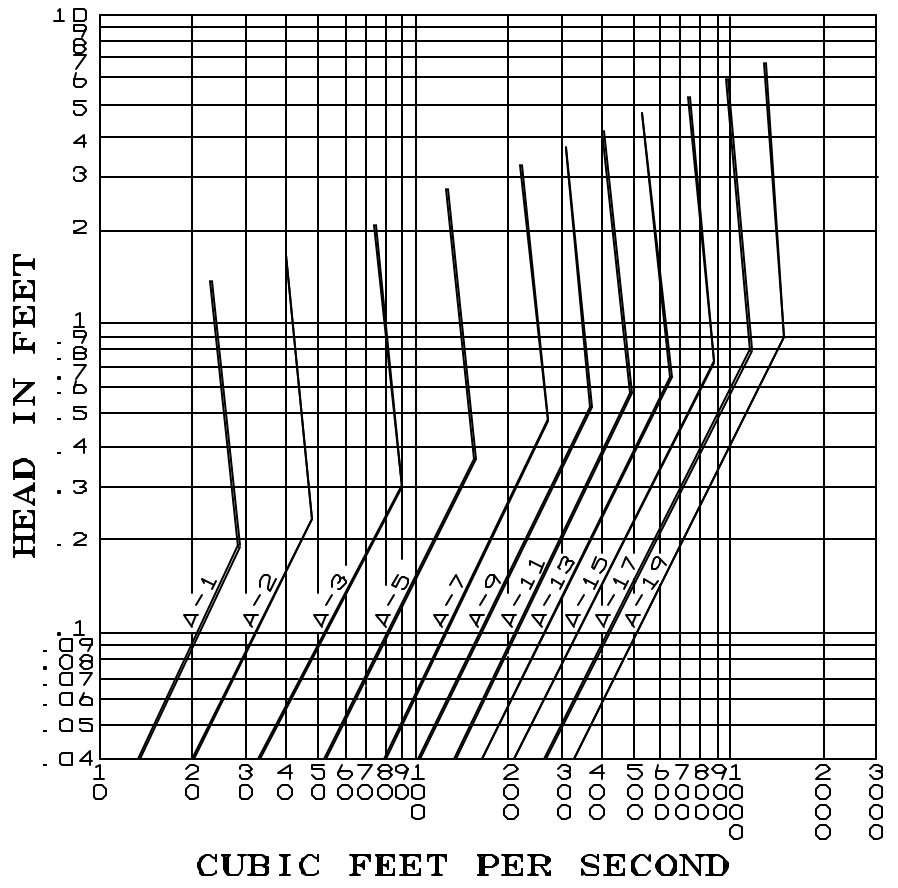

**EXAMPLE I:**

Water flows from a reservoir to a canal.

What gate should be used to control the flow from the reservoir in order to maintain a constant water level in the canal irrespective of the level in the reservoir and irrespective of the water demand?

- withdrawal rate varies from 15 to 250 cfs
- level in the reservoir can fluctuate between 100.90 and 107.00 ft.
- desired Constant Level in canal: 100.00ft.

Point A<sup>1</sup> is defined by:

1 100.90 - 100.00 = 0.90  
ft.

2 250 cfs

Point B<sup>1</sup> is defined by:

3 107.00 - 100.00 = 7.00  
ft.

4 250 cfs

The Type B-16 is the smallest gate whose characteristics encompass A<sup>1</sup> and B<sup>1</sup> and is therefore the gate to be selected.

Note that no Type "A" gate will answer the problem: the Type B-21 could, but this gate is much larger than the Type B-16.

**EXAMPLE II:**

A control structure is to be installed in a canal to maintain a constant downstream water level irrespective of the discharge in the canal.

- desired constant downstream level: 180.00 ft
- at maximum flow of 100 cfs the water level in the canal upstream of the structure is 180.10 ft
- at minimum flow of 30 cfs the water level in the canal upstream of the structure is 183.00 ft

Point A<sup>2</sup> is defined by:

1 180.10 - 180.00 = 0.10  
ft

2 100 cfs

Point B<sup>2</sup> is defined by:

3 183.00 - 180.00 = 3.00  
ft

4 30 cfs.

The Type A-18, Type A-7, Type B-18 and Type B-21 have characteristics which encompass A<sup>2</sup> and B<sup>2</sup>. However, since the Type A-7 is the smallest, it is the gate to be selected.

- 1 - Max. upstream level
- 2 - Constant downstream level
- 3 - Sluice dimensions
- 4 - Cross-section downstream of gate leaf

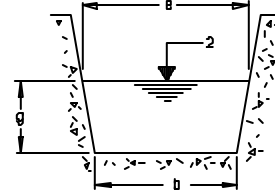
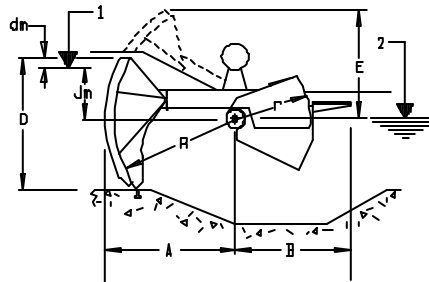
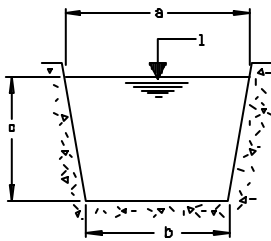
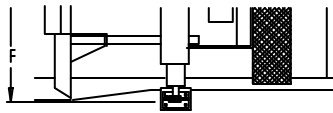

TYPE A		Overall Dimensions															
High Head	Low Head	A	B*	C*	D	E	F	R	r	Jm	dm	b	e	g	a	b	c
A-1		40.25	24.5	64.5	38.5	35.5	55	35.5	22	15.75	.75	41.75	49.25	22	54.5	41.75	37.75
A-2		50	30.75	80.75	48.5	43.25	71.25	44	28	19.75	1	52	63	28	70.75	52	47.75
A-3		62.25	39.25	101.5	61.5	53.25	87.5	55	35.5	24.75	1.25	67	78.75	35.5	87	67	60.25
	A-4	70.75	39.25	110.25	54.5	51.25	93.25	63	35.5	14	1.25	74.75	88.25	39.25	93	74.75	53.25
A-5		79.5	74.75	154.25	77.25	69	112.5	70.75	43.25	31.50	1.5	83.5	98.5	44	109.25	83.5	75.5
	A-6	88.5	74.75	163.5	68.50	65	124.5	78.75	43.25	17.75	1.5	93	110.25	49.25	116.5	93	67
A-7		99.25	82.75	182	96.5	84.5	141.75	88.25	55	39.25	2	104.25	124	55	138	104.25	94.5
	A-8	111	82.75	193.75	87	80.75	157.50	98.5	55	22	2	118	139.75	63	147.5	118	85
A-9		111	91.75	202.75	108.5	94.5	158.25	98.5	63	43.25	2.25	118	139.75	63	154.75	118	106.25
	A-10	124	91.75	215.75	97.75	90.5	176	110.25	63	24.75	2.25	132	157.5	70.75	166.25	131.75	95.75
A-11		124	100	224	122.5	106.25	179.25	110.25	70.75	49.25	2.25	132	157.5	70.75	175.25	132	120
	A-12	139.75	100	239.75	108.75	102.25	198.75	124	70.75	27.5	2.25	147.75	177.25	78.75	187.5	147.75	106.25
A-13		139.75	107.75	247.75	136.5	118	199.5	124	78.75	55	2.75	147.75	177.25	78.75	197.75	147.75	133.75
	A-14	157.5	107.75	265.25	122.5	114.25	219.25	139.75	78.75	31.5	2.75	167.25	196.75	88.25	207.5	167.25	119.75
A-15		157.5	119	276.5	154.25	133.75	224.75	139.75	86.5	63	3.25	167.25	196.75	88.25	218	167.25	151.25
	A-16	177.25	119	296	137	128	248.5	157.5	86.5	35.5	3.25	187	220.5	98.5	232.5	187	133.75
A-17		177.25	130.25	307.5	172.75	149.5	249.5	157.5	98.5	70.75	3.5	187	220.5	98.5	244.75	187	169.25
	A-18	196.75	130.75	327.25	153.25	143.75	277.25	177.25	98.5	39.25	3.5	208.75	248	110.25	262.25	208.75	149.5
A-19		196.75	141.75	338.5	193	169.25	280.75	177.25	110.25	78.75	4	208.75	248	110.25	276.25	208.75	189
	A-20	222.5	141.75	364.25	171.25	159.5	312.25	196.75	110.25	43.25	4	236.25	279.5	124	294.75	236.25	167.25

DIMENSIONS IN INCHES

\* Dimensions are approximate and subject to change.

**TYPICAL SPECIFICATION FOR  
WATERMAN TYPE "A" AUTOMATIC LEVEL CONTROL GATE**

**1. APPLICABLE PUBLICATIONS.** The Steel Structures Painting Council (SSPC) Publications listed below form a part of this specification to the extent referenced. The publications are referred to in the text by the basic designation only

SSPC SP 10	Near White Blast Clean
SSPC PS 11.01	(1982) Black (or Dark Red) Coal Tar Epoxy Painting System

**2. SUBMITTALS**

**2.1 Shop Drawings.** Shop drawings shall be submitted in accordance with the SPECIAL CLAUSES. Submittals shall include a complete list of equipment and materials, including manufacturer's descriptive and technical literature, performance charts and curves, catalog cuts, and installation instructions. Drawings shall show proposed layout and anchorage of the system and appurtenances, design of structure to receive gates and equipment relationship to other parts of the work including clearances for maintenance and operation. Manufacturer's descriptive data and installation instructions shall be submitted for approval.

**2.2 Certificate of Compliance.** A certificate of compliance that the gates furnished are in conformance with the drawings and specifications shall be submitted to the project engineer.

**2.3 Operating Instructions.** The manufacturer shall furnish the engineer with six (6) complete copies of operating characteristics and instructions outlining the step-by-step procedure required for system start-up and system operation. The instructions shall include the manufacturer's name, model number, service manual, parts list, and brief description of all equipment and their basic operating features.

**2.4 Maintenance Instructions.** The manufacturer shall furnish the engineer with six (6) copies of maintenance instructions listing routine maintenance procedures, possible breakdown and repairs, and troubleshooting guide.

**2.5 Spare Parts Data.** After approval of the shop drawings, the contractor shall furnish spare parts data for each different item of materials and equipment furnished. Data shall include a complete list of spare parts and supplies, with current unit prices and source of supply.

**3. MANUFACTURER'S SERVICES.** The Contractor shall obtain the services of a factory field representative experienced in the calibration and balancing of the equipment specified. The representative shall supervise the calibration and balancing of the equipment for proper operation.

**4. SHIPMENT AND DELIVERY.** Gates shall be shipped from factory in components or sub-assemblies to be bolted together in the field to the exclusion of any field welding. The dimensions of individual components shall be compatible with rail or road transportations clearances. Match marks shall be provided on the heaviest components to facilitate field erection. When shipping and delivering gate components, the gates shall be handled carefully to ensure a sound, undamaged condition. Particular care shall be taken not to damage any coating.

**5. MATERIALS.**

**5.1 General.** The automatic level control gate shall be constant downstream level, Waterman Type "A", and be completely self-operating with an integrated float-ballast design. The gate shall be as manufactured by Waterman Industries, Inc., or an approved equal in quality, characteristics and performance.

**5.2** Steel shall be ASTM A-36.

**TYPICAL SPECIFICATION FOR  
WATERMAN TYPE "A" AUTOMATIC LEVEL CONTROL GATE (CONTINUED)**

**5.3 Standard Products.** Materials and equipment shall be the standard product of a manufacturer regularly engaged in the manufacture of this type of product and shall essentially duplicate items that have been in satisfactory service for more than five (5) years prior to bid opening. Substitute manufacturer may submit alternate design which has been tested and certified by an independent laboratory. All materials used in construction of the gate shall be new and selected according to the best engineering practice for this type of equipment. Equipment shall be supported by a service organization that is, in the opinion of the engineer, reasonably convenient to the site.

**6. OPERATION REQUIREMENTS.** The gate shall operate automatically, regulating the downstream water level with no external power, motor or level sensors and hoists, and no manual intervention, under the following conditions:

(insert your particulars here, such as elevations, head differential and flows)

**6.1** Within the above specified limits, the downstream level shall be controlled irrespective of the upstream level conditions, gate opening and discharge rates.

**7. GATE CONSTRUCTION.**

**7.1** The gates shall be fabricated from materials as per paragraph 5, Materials, and designed to withstand the pressure forced produced by the upstream water level at its maximum elevation, with no tailwater (and, as the case may be, by the exceptional maximum tailwater level).

**7.2** The gates shall mainly consist of a radially shaped faceplate, suitably reinforced and matching trapezoidal-shaped sluice way, a framework including the float and ballasting compartments, and two roller bearings enclosed in sealed housings to be anchored in the concrete structure.

**7.3** The float ballast compartment shall be protected by a shield specially designed to prevent any silt deposit likely to impair the traveling of the moving assembly.

**7.4** The gates shall include an adjustable counterweight, suitable for accurate, sensitive and stable gate operation. The leakage rate in the closed position shall not exceed 3 cfs. The gate shall be carefully checked and adjusted to tolerances required in the factory for straight forward field erection and proper operation.

**8.0 SURFACE PREPARATION AND PAINTING.** Surface preparation shall consist of near white blast cleaning of all surfaces (SSPC SP-10). Mechanical surfaces shall be protected by appropriate masking. Protective coating shall consist of:

- a. On machined surfaces, one coat of gasoline-soluble, rust-preventing compound.
- b. On all other surfaces, including surfaces to be grouted in, two coats of factory applied coal tar epoxy paint (SSPC PS 11.01) for corrosion protection from water and corrosive environment.
- c. Coating touch-up kit.

(Alternate surface preparations and coatings may be specified.)



# TYPE "B"

## AUTOMATIC DOWNSTREAM LEVEL CONTROL GATE

Waterman Type "B" gates are designed for sluice installations, usually controlling an orifice set in a breastwall, and permitting a higher upstream head.

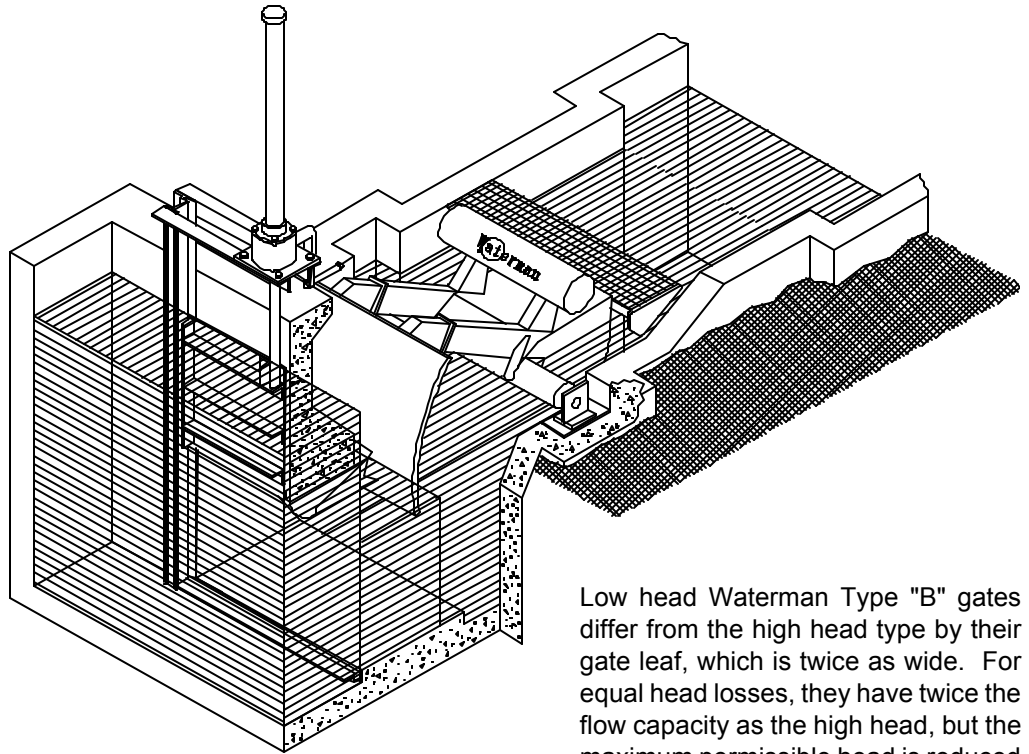

Cutaway drawing of a Waterman Type "B" gate installation (note breastwall and optional stop gate)

Low head Waterman Type "B" gates differ from the high head type by their gate leaf, which is twice as wide. For equal head losses, they have twice the flow capacity as the high head, but the maximum permissible head is reduced by half.

### GATE SELECTION

Selection is based on the required hydraulic performance of the installation.

The gate to be selected is the smallest one (smallest index number) whose head-discharge curve, represented on the selection charts, encompasses all possible head/discharge operating points which may be encountered for the installation.

For example, the following data are typical and define two significant operating points, A and B:

Minimum head differential [1] under which the maximum discharge [2] must be delivered.

[1] and [2] define point A.

Maximum head differential [3] and largest discharge [4] to be delivered under this maximum head differential.

[3] and [4] define point B.

See following page.

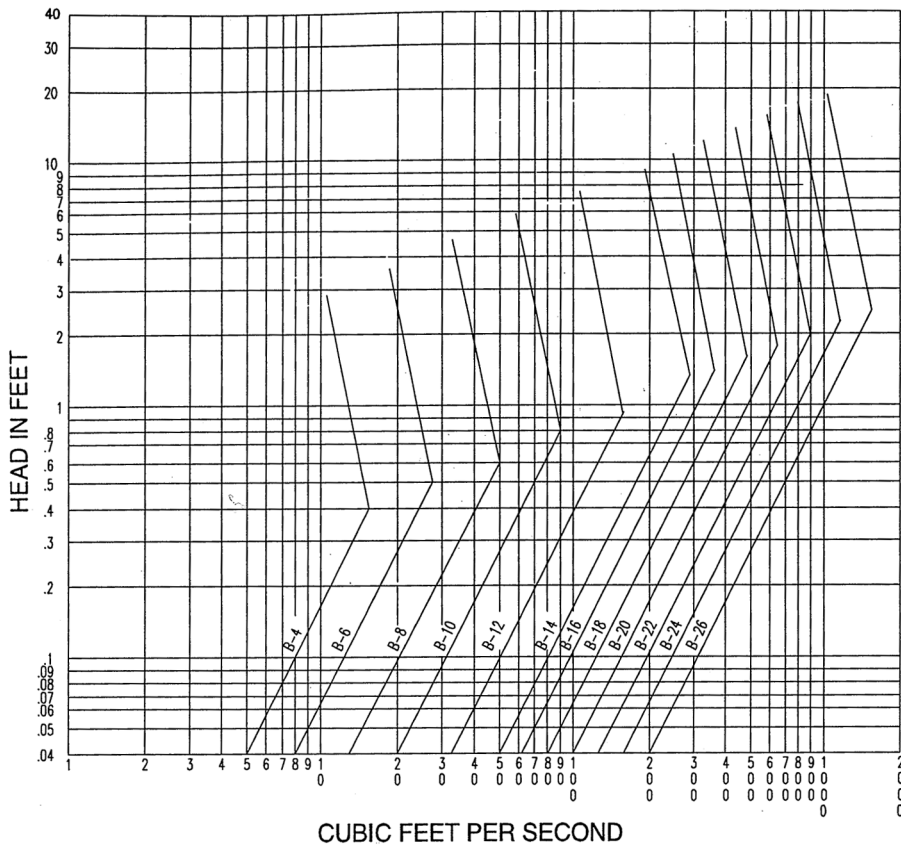

TYPE "B"  
HIGH HEAD  
GATE SELECTION CHART

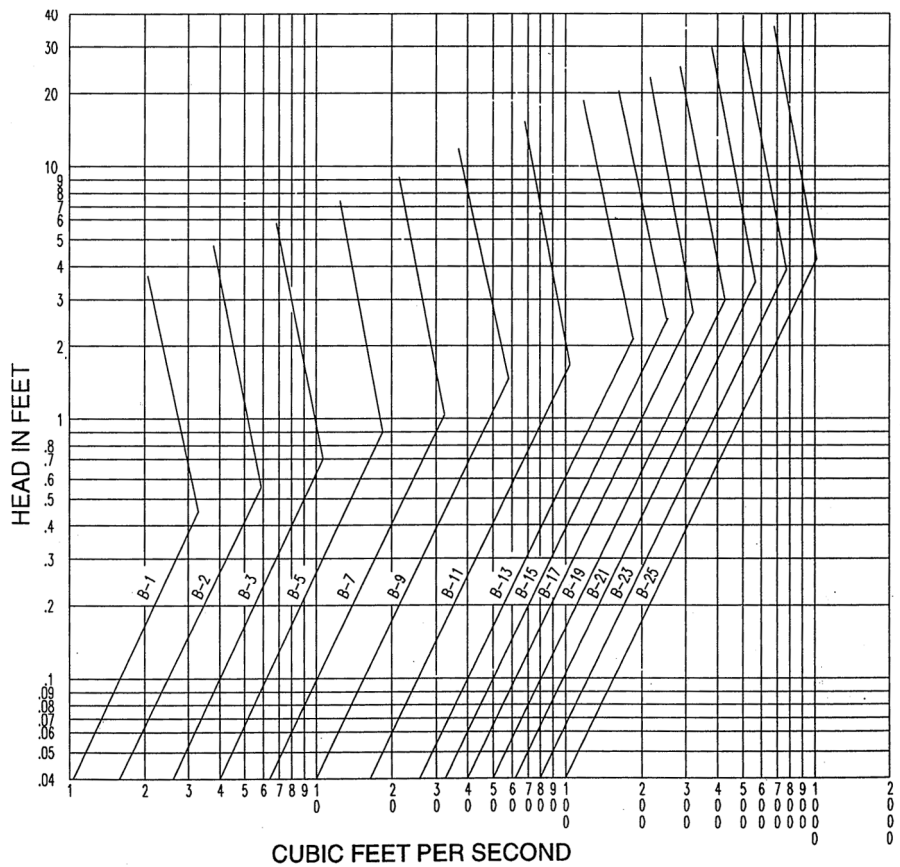

**EXAMPLE I:**

Water flows from a reservoir to a canal.

What gate should be used to control the flow from the reservoir in order to maintain a constant water level in the canal irrespective of the level in the reservoir and irrespective of the water demand?

- withdrawal rate varies from 15 to 250 cfs
- level in the reservoir can fluctuate between 100.90 and 107.00 ft.
- desired Constant Level in canal: 100.00ft.

Point A<sup>1</sup> is defined by:

1 100.90 - 100.00 = 0.90 ft.

2 250 cfs

Point B<sup>1</sup> is defined by:

3 107.00 - 100.00 = 7.00 ft.

4 250 cfs

The Type B-16 is the smallest gate whose characteristics encompass A<sup>1</sup> and B<sup>1</sup> and is therefore the gate to be selected.

Note that no Type "A" gate will answer the problem: the Type B-21 could, but this gate is much larger than the Type B-16.

**EXAMPLE II:**

A control structure is to be installed in a canal to maintain a constant downstream water level irrespective of the discharge in the canal.

- desired constant downstream level: 180.00 ft
- at maximum flow of 100 cfs the water level in the canal upstream of the structure is 180.10 ft
- at minimum flow of 30 cfs the water level in the canal upstream of the structure is 183.00 ft

Point A<sup>1</sup> is defined by:

1 180.10 - 180.00 = 0.10 ft.

2 100 cfs

Point B<sup>2</sup> is defined by:

3 183.00 - 180.00 = 3.00 ft.

4 30 cfs

The Type A-18, Type A-7, Type B-18 and Type B-21 have characteristics which encompass A<sup>2</sup> and B<sup>2</sup>. However, since the Type A-7 is the smallest, it is the gate to be selected.

**High-head and Low-head Waterman Type B Gates from B-1 to B-26**

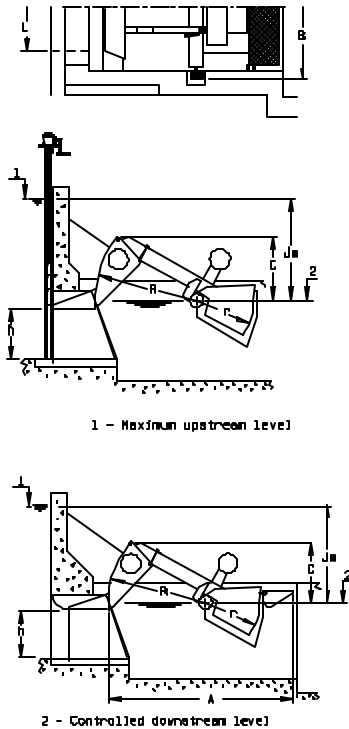

TYPE B		Overall Dimensions					Max. Head	Opening	
High Head	Low Head	A*	B	C	R	r	Jm	h	L
B-1		35.5	27.5	13.75	19.75	11	44	9.75	9.75
B-2		43.25	33.5	17.75	24.75	14.25	55	12.5	12.5
B-3		55	40.5	21.75	31.5	17.75	70.75	15.75	15.75
	B-4	55	40.5	21.75	31.5	17.75	35.5	15.75	31.5
B-5		67	47.25	27.50	39.25	22	88.25	19.75	19.75
	B-6	67	47.25	27.50	39.25	22	44	19.75	39.25
B-7		82.75	63	35.5	49.25	28	110.25	24.75	24.75
	B-8	82.75	63	35.5	49.25	28	55	24.75	49.25
B-9		104.25	78.75	43.25	63	35.5	139.75	31.5	31.5
	B-10	104.25	78.75	43.25	63	35.5	70.75	31.5	63
B-11		153.5	126	55	78.75	43.25	177.25	39.25	39.25
	B-12	153.5	126	55	78.75	43.25	88.25	39.25	78.75
B-13		185	161.5	70.75	98.5	55	220.5	49.25	49.25
	B-14	185	161.5	70.75	98.5	55	110.25	49.25	98.5
B-15		204.75	177.25	78.75	110.25	63	248	55	55
	B-16	204.75	177.25	78.75	110.25	63	124	55	110.25
B-17		228.25	200.75	86.5	124	70.75	279.5	63	63
	B-18	228.25	200.75	86.5	124	70.75	139.75	63	124
B-19		252	220.5	98.5	139.75	78.75	315	70.75	70.75
	B-20	252	220.5	98.5	139.75	78.75	157.5	70.75	139.75
B-21		279.5	250	110.25	157.5	86.5	354.25	78.75	78.75
	B-22	279.5	250	110.25	157.5	86.5	117.25	78.75	157.5
B-23		311	279.5	126	177.25	98.5	393.75	86.5	86.5
	B-24	311	279.5	126	177.25	98.5	196.75	86.5	177.25
B-25		342.5	315	137.75	196.75	110.25	433	98.5	98.5
	B-26	342.5	315	137.75	196.75	110.25	220.5	98.5	196.75

DIMENSIONS IN INCHES  
\* Dimensions are approximate and subject to change.

**TYPICAL SPECIFICATION FOR  
WATERMAN TYPE "B" AUTOMATIC LEVEL CONTROL GATE**

**1. APPLICABLE PUBLICATIONS.** The Steel Structures Painting Council (SSPC) Publications listed below form a part of this specification to the extent referenced. The publications are referred to in the text by the basic designation only

SSPC SP 10	Near White Blast Clean
SSPC PS 11.01	(1982) Black (or Dark Red) Coal Tar Epoxy Painting System

**2. SUBMITTALS**

**2.1 Shop Drawings.** Shop drawings shall be submitted in accordance with the SPECIAL CLAUSES. Submittals shall include a complete list of equipment and materials, including manufacturer's descriptive and technical literature, performance charts and curves, catalog cuts, and installation instructions. Drawings shall show proposed layout and anchorage of the system and appurtenances, design of structure to receive gates and equipment relationship to other parts of the work including clearances for maintenance and operation. Manufacturer's descriptive data and installation instructions shall be submitted for approval.

**2.2 Certificate of Compliance.** A certificate of compliance that the gates furnished are in conformance with the drawings and specifications shall be submitted to the project engineer.

**2.3 Operating Instructions.** The manufacturer shall furnish the engineer with six (6) complete copies of operating characteristics and instructions outlining the step-by-step procedure required for system start-up and system operation. The instructions shall include the manufacturer's name, model number, service manual, parts list, and brief description of all equipment and their basic operating features.

**2.4 Maintenance Instructions.** The manufacturer shall furnish the engineer with six (6) copies of maintenance instructions listing routine maintenance procedures, possible breakdown and repairs, and troubleshooting guide.

**2.5 Spare Parts Data.** After approval of the shop drawings, the contractor shall furnish spare parts data for each different item of materials and equipment furnished. Data shall include a complete list of spare parts and supplies, with current unit prices and source of supply.

**3. MANUFACTURER'S SERVICES.** The Contractor shall obtain the services of a factory field representative experienced in the calibration and balancing of the equipment specified. The representative shall supervise the calibration and balancing of the equipment for proper operation.

**4. SHIPMENT AND DELIVERY.** Gates shall be shipped from factory in components or sub-assemblies to be bolted together in the field to the exclusion of any field welding. The dimensions of individual components shall be compatible with rail or road transportations clearances. Match marks shall be provided on the heaviest components to facilitate field erection. When shipping and delivering gate components, the gates shall be handled carefully to ensure a sound, undamaged condition. Particular care shall be taken not to damage any coating.

**5. MATERIALS.**

**5.1 General.** The automatic level control gate shall be constant downstream level, Waterman Type "B", and be completely self-operating with an integrated float-ballast design. The gate shall be as manufactured by Waterman Industries, Inc., or an approved equal in quality, characteristics and performance.

**TYPICAL SPECIFICATION FOR  
WATERMAN TYPE "B" AUTOMATIC LEVEL CONTROL GATE (CONTINUED)**

**5.2** Steel shall be ASTM A-36.

**5.3 Standard Products.** Materials and equipment shall be the standard product of a manufacturer regularly engaged in the manufacture of this type of product and shall essentially duplicate items that have been in satisfactory service for more than five (5) years prior to bid opening. Substitute manufacturer may submit alternate design which has been tested and certified by an independent laboratory. All materials used in construction of the gate shall be new and selected according to the best engineering practice for this type of equipment. Equipment shall be supported by a service organization that is, in the opinion of the engineer, reasonably convenient to the site.

**6. OPERATION REQUIREMENTS.** The gate shall operate automatically, regulating the downstream water level with no external power, motor or level sensors and hoists, and no manual intervention, under the following conditions:

(insert your particulars here, such as elevations, head differential and flows)

**6.1** Within the above specified limits, the downstream level shall be controlled irrespective of the upstream level conditions, gate opening and discharge rates.

**7. GATE CONSTRUCTION.**

**7.1** The gates shall be fabricated from materials as per paragraph 5, Materials, and designed to withstand the pressure forced produced by the upstream water level at it's maximum elevation, with no tailwater (and, as the case may be, by the exceptional maximum tailwater level).

**7.2** The gates shall mainly consist of a radially shaped faceplate, suitably reinforced and matching trapezoidal-shaped sluice way, a framework including the float and ballasting compartments, and two roller bearings enclosed in sealed housings to be anchored in the concrete structure.

**7.3** The float ballast compartment shall be protected by a shield specially designed to prevent any silt deposit likely to impair the traveling of the moving assembly.

**7.4** The gates shall include an adjustable counterweight, suitable for accurate, sensitive and stable gate operation. The leakage rate in the closed position shall not exceed 3 cfs. The gate shall be carefully checked and adjusted to tolerances required in the factory for straight forward field erection and proper operation.

**8.0 SURFACE PREPARATION AND PAINTING.** Surface preparation shall consist of near white blast cleaning of all surfaces (SSPC SP 10). Mechanical surfaces shall be protected by appropriate masking. Protective coating shall consist of:

- a. On machined surfaces, one coat of gasoline-soluble, rust-preventing compound.
- b. On all other surfaces, including surfaces to be grouted in, two coats of factory applied coal tar epoxy paint (SSPC PS 11.01) for corrosion protection from water and corrosive environment.
- c. Coating touch-up kit.

(Alternate surface preparations and coatings may be specified.)

## Control of Detention Basin Outlets: A Typical Application of the WATERMAN TYPE "B" CONSTANT DOWNSTREAM LEVEL GATE

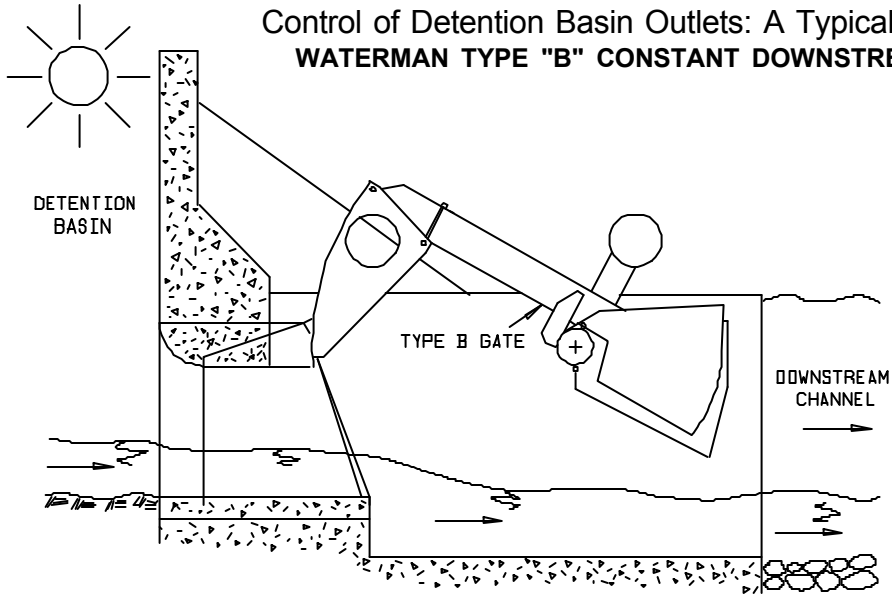

### NORMAL FLOW CONDITION

The Type "B" Gate is fully open and remains conveniently out of the flow. Large cross section area of the sluice minimizes chances of clogging. As long as the runoff does not exceed the downstream canal full capability the detention basin is kept empty, its storage capacity available to its maximum value.

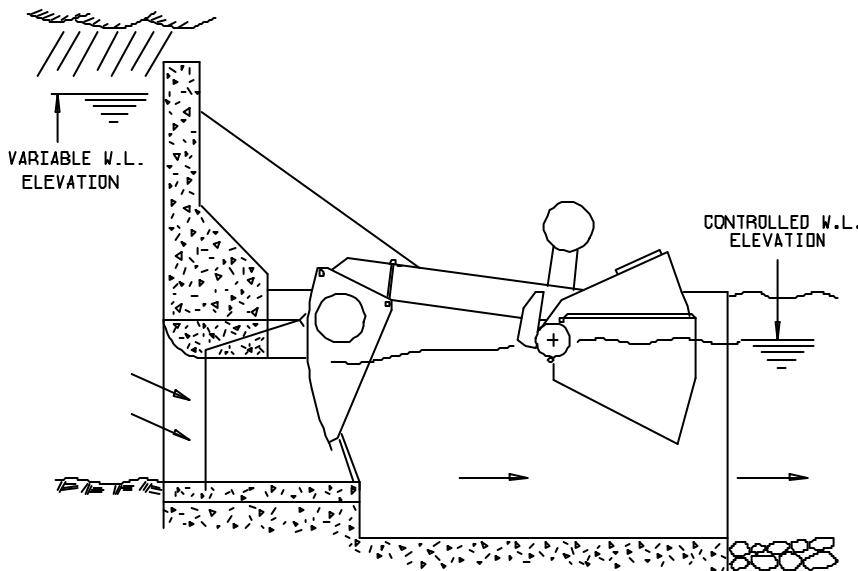

### FLOOD CONDITION

When, and only when, the incoming runoff exceeds the canal capacity does the Type "B" Gate back up the excess flow in the detention basin.

Maintaining a constant water line at the head of the canal the Type "B" Gate releases only the discharge that can be handled.

Computer? Electronics? Motors? No! Not even a single switch... and yet the sturdy Type "B" Gate does precisely what is required from a detention basin outlet. With the Waterman Type "B" Gates, costly detention basins and draining canals become 100% efficient

### TYPE "A" / TYPE "B" Gate Applications

- Demand Control** - The headworks to an open canal can be automated with the use of Waterman Type "A"/Type "B" downstream level control gates providing required flows "on demand."
- Irrigation Canals** - Automatic canal check gates for reliable turnout control at "demand" flows.
- Flood Control** - Control of detention basin outlets. Basins are kept empty until the runoff exceeds the downstream canal full capability at which time the Waterman Type "A"/Type "B" gates will back up the flow in the detention basin. The gates release only the discharge that can be handled.
- Constant Source Flow** - Provides needed supply to cooling water recirculation systems or wet-wells for pump stations.
- Wastewater Treatment** - Flow through the headworks can be equalized during peak and off-peak hours by using a Waterman Type "A"/Type "B" downstream control gate as the main influent gate. During peak flows the excess will be retained upstream of the gate and during off-peak flows the gate would remain open.  
- By using the Waterman Type "A"/Type "B" gate as a "demand control" device sedimentation basin levels can be automatically regulated during fluctuating flow rates.

## TYPICAL DETENTION BASIN APPLICATION

Redbank Creek detention basin.

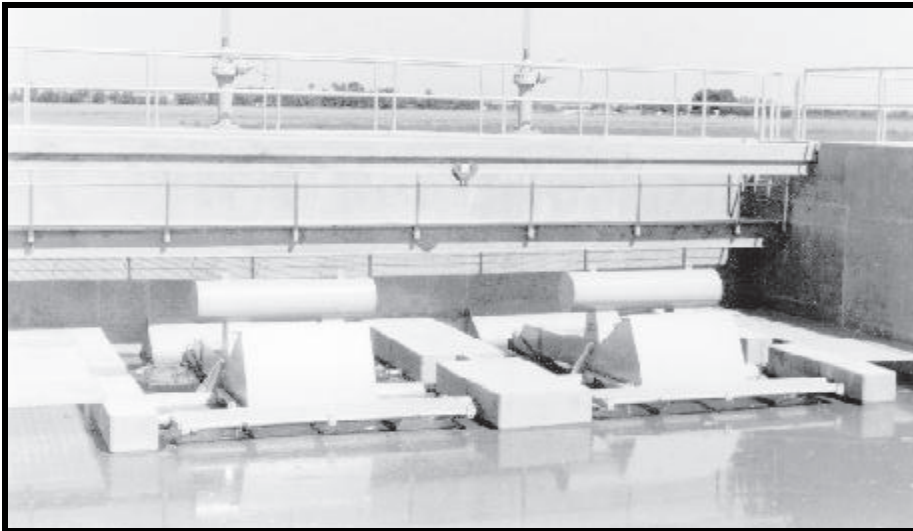

Downstream side of dam showing outlet control structure.

Upstream side of dam showing manual sluice gates which are used when complete shut-off is desired.

